







## Assembly instructions

### Please note before use:

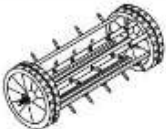
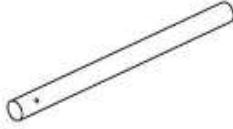
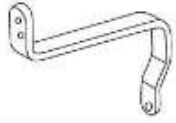
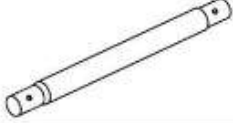
Please read the instructions carefully and make yourself familiar with the device. Please follow the assembly instructions step by step and check all parts for completeness. To prevent damage to the components, please place them all on the floor. Keep sharp-edged parts and packaging out of the reach of children. If parts are dirty, please clean them with a duster; do not use abrasive cleaners.

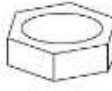
### Usage

The lawn aerator should not be knocked uncontrollably. The best results are achieved when the lawn is slightly moist. Sufficient ventilation is achieved by increasing the pressure on the lawn aerator via the hand guide.

PART No.	DESCRIPTION	DIAGRAM	QTY. (pcs)	PART No.	DESCRIPTION	DIAGRAM	QTY. (pcs)
A	main unit		1	H	tube-A		1
B	bottom frame		2	I	tube-B		1
C	large washer		2	J	tube-C		1
D	large nut		2				
E	screw		2				
F	small nut		2				
G	small washer		2				

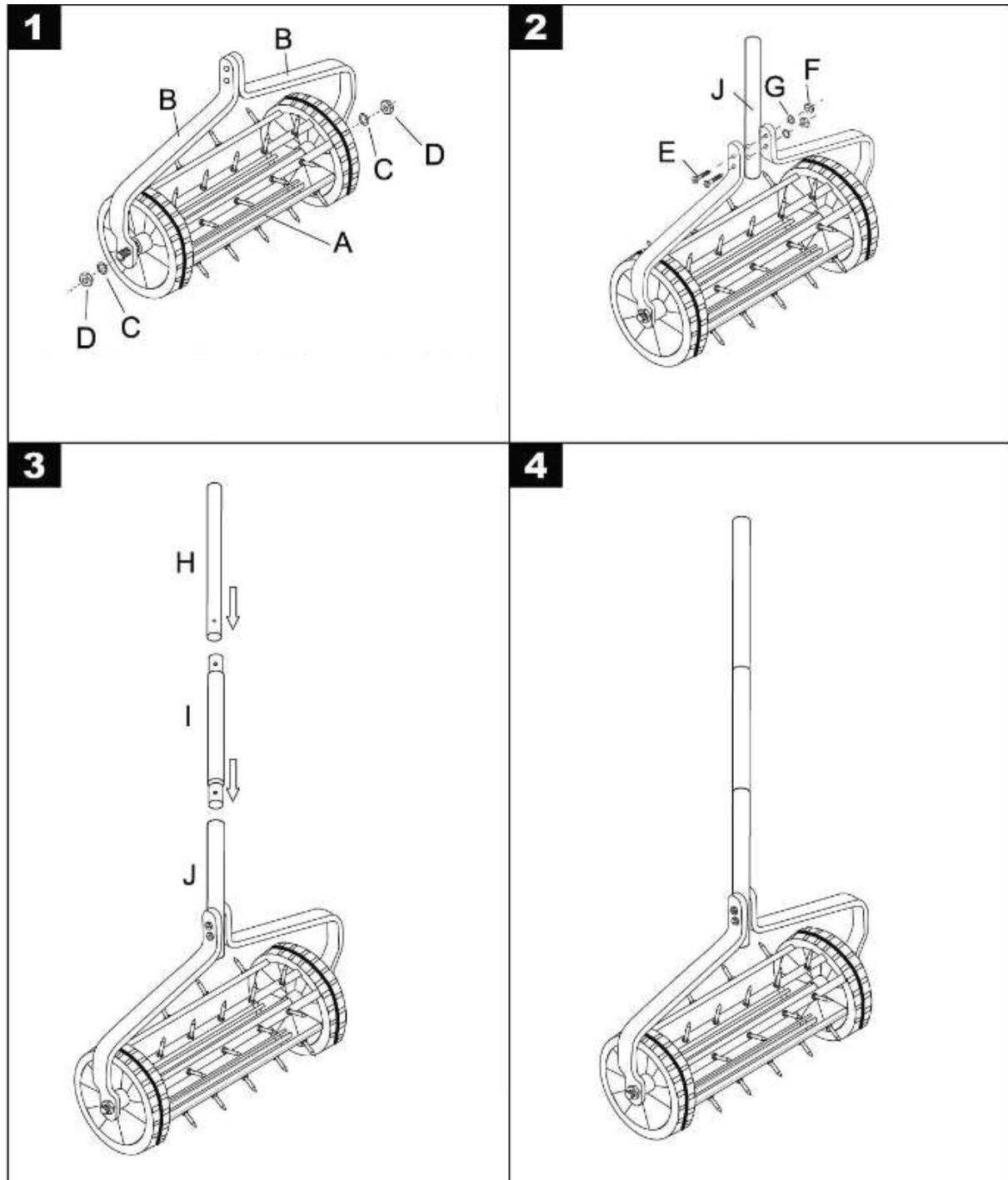

**Warning**

Prevent contact with the ventilation mandrels. These are sharp and can cause serious injury if not used correctly.

**Maintenance**

Please clean the ventilation thorns and the wheels carefully after use. Store in a dry place. Please lubricate all moving parts with a little conventional oil regularly to ensure proper use over the long term.